

TEHNIČNI LIST – DIMENZIJE HIDROMOTORJI MR

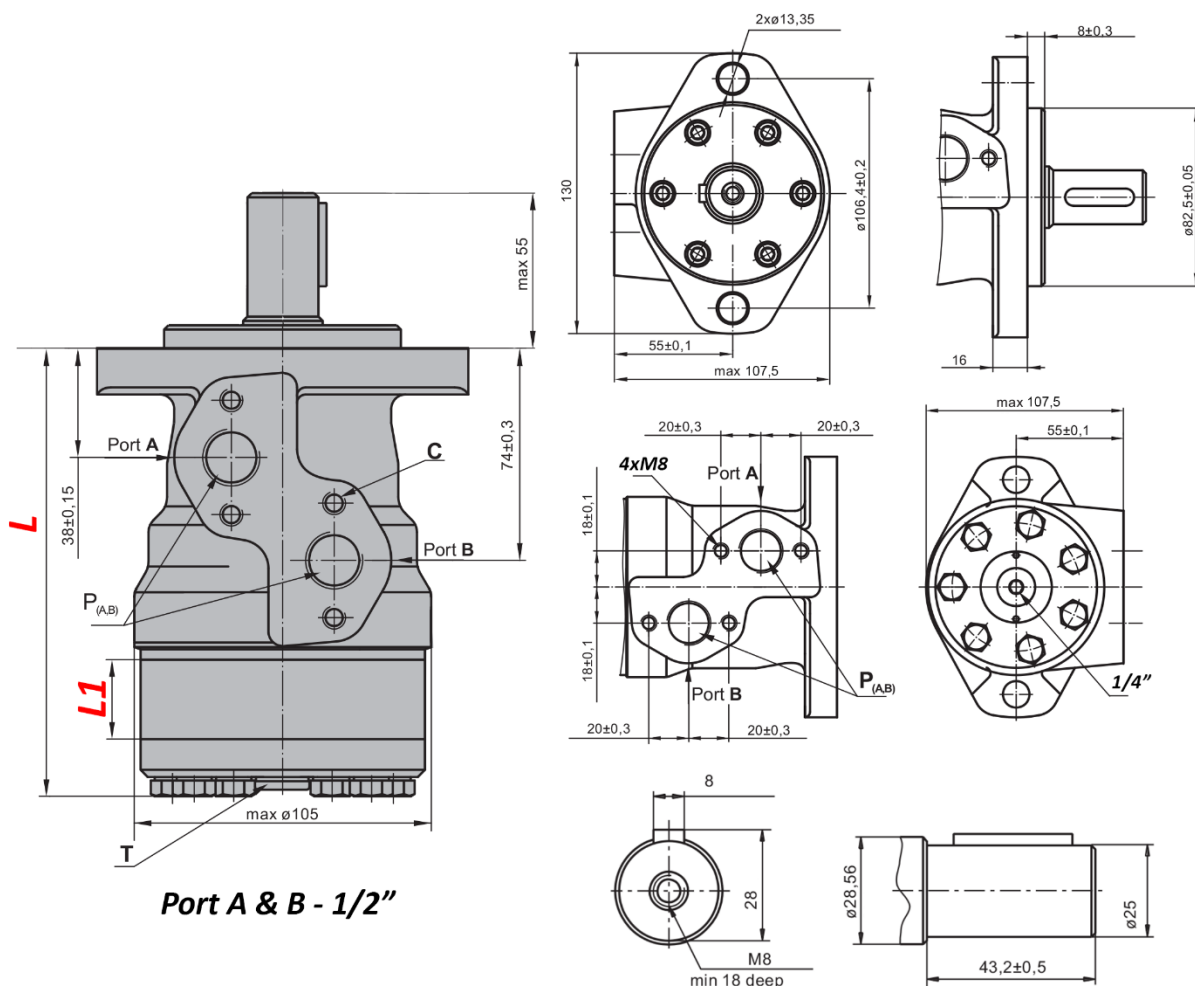

	L	L1
	(mm)	(mm)
MR 40	136,5	7,4
MR 50	135,5	6,67
MR 80	139,5	10,67
MR 100	142	13,33
MR 125	145,5	16,67
MR 160	150	21,33
MR 200	155,5	26,67
MR 250	162	33,33
MR 315	171,5	42,67
MR 400	182	53,33

		MR 50	MR 80	MR 100	MR 125	MR 160	MR 200	MR 250	MR 315	MR 400
cm/vrtljaji		51,5	80,3	99,8	125,7	159,6	199,8	250,1	315,7	397
Vrtljaji [rpm]	konstantni	775	750	600	475	375	300	240	190	150
	s prekinitvami	970	940	750	600	470	375	300	240	190
Navor [daNm]	konstantni	10	20	24	30	39	45	54	55	61
	s prekinitvami	13	22	28	34	43	50	61	69	69
	max.	17	27	32	37	46	56	71	84	87
Moč [kW]	konstantna	7	12,5	13	12,5	11,5	11	10	9	7,8
	s prekinitvami	8,5	15	15	14,5	14	13	12	10	10,6
Priključni tlak [bar]	konstantni	175	175	175	175	175	175	175	175	175
	s prekinitvami	200	200	200	200	200	200	200	200	200
	max.	225	225	225	225	225	225	225	225	225
Padec tlaka [bar]	konstantni	140	175	175	175	175	175	175	135	110
	s prekinitvami	175	200	200	200	200	200	200	175	140
	max.	225	225	225	225	225	225	225	210	175
Pretok olja [L/min]	konstantni	40	60	60	60	60	60	60	60	60
	s prekinitvami	50	75	75	75	75	75	75	75	75
Priključni navoj		1/2"	1/2"	1/2"	1/2"	1/2"	1/2"	1/2"	1/2"	1/2"
Teža [kg]		6,9	7	7,3	7,4	7,6	8,1	8,5	9,2	9,9



DIAGRAMI

MR 50

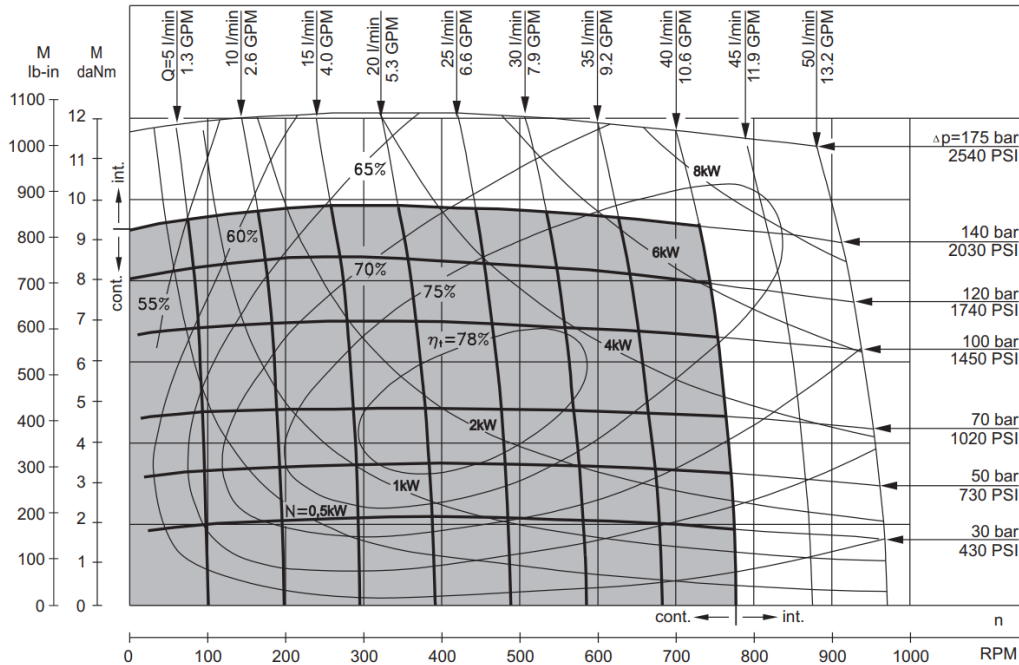

MR 80

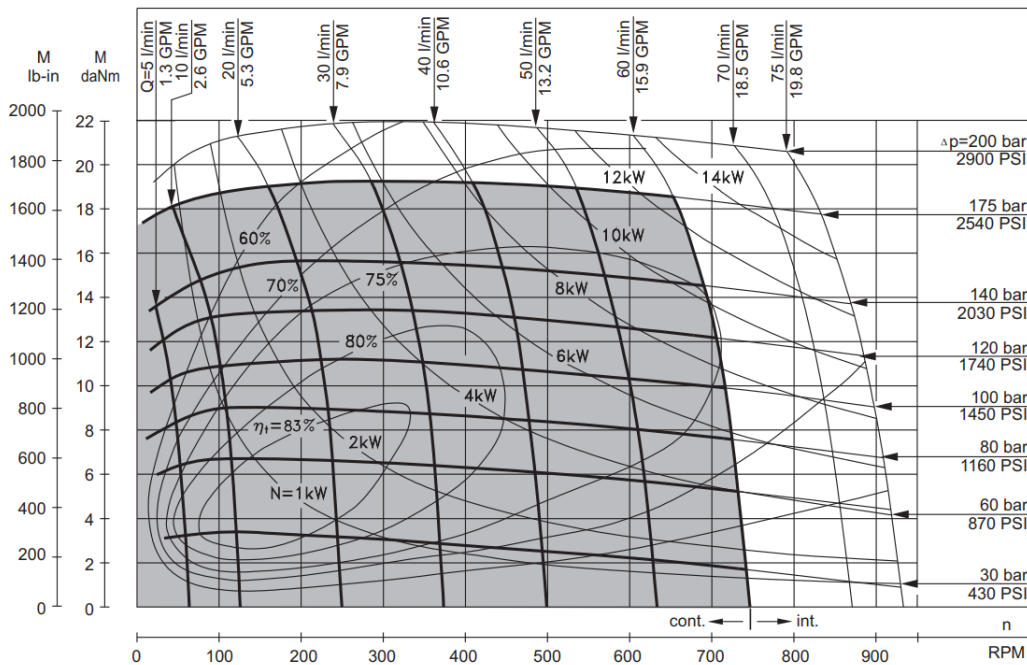

MR 100

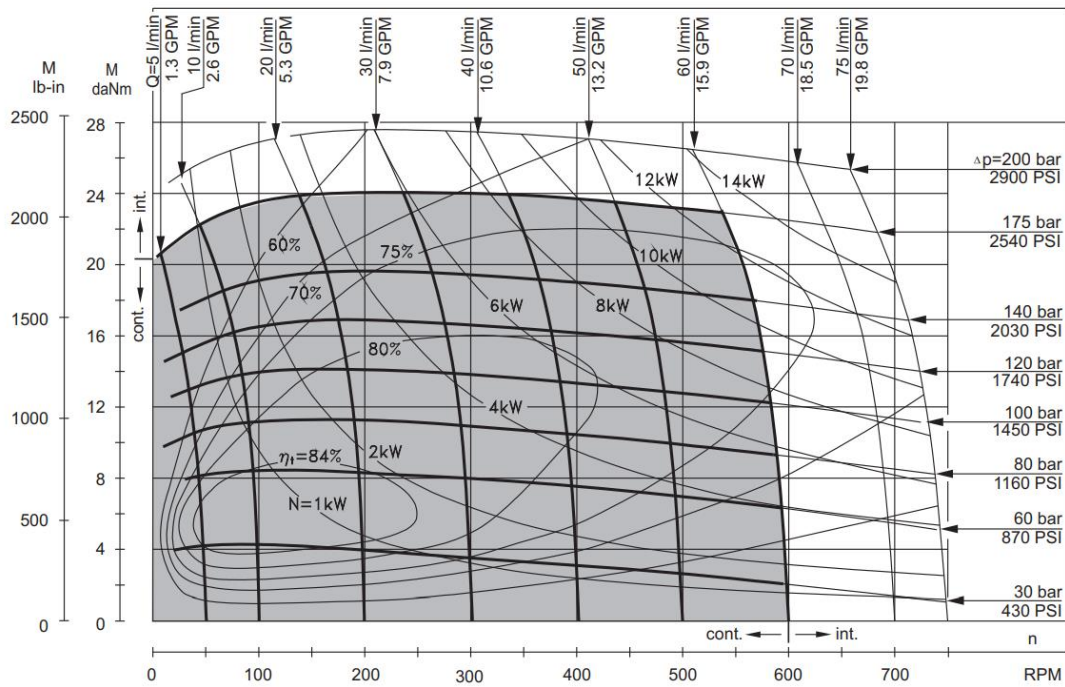

MR 125

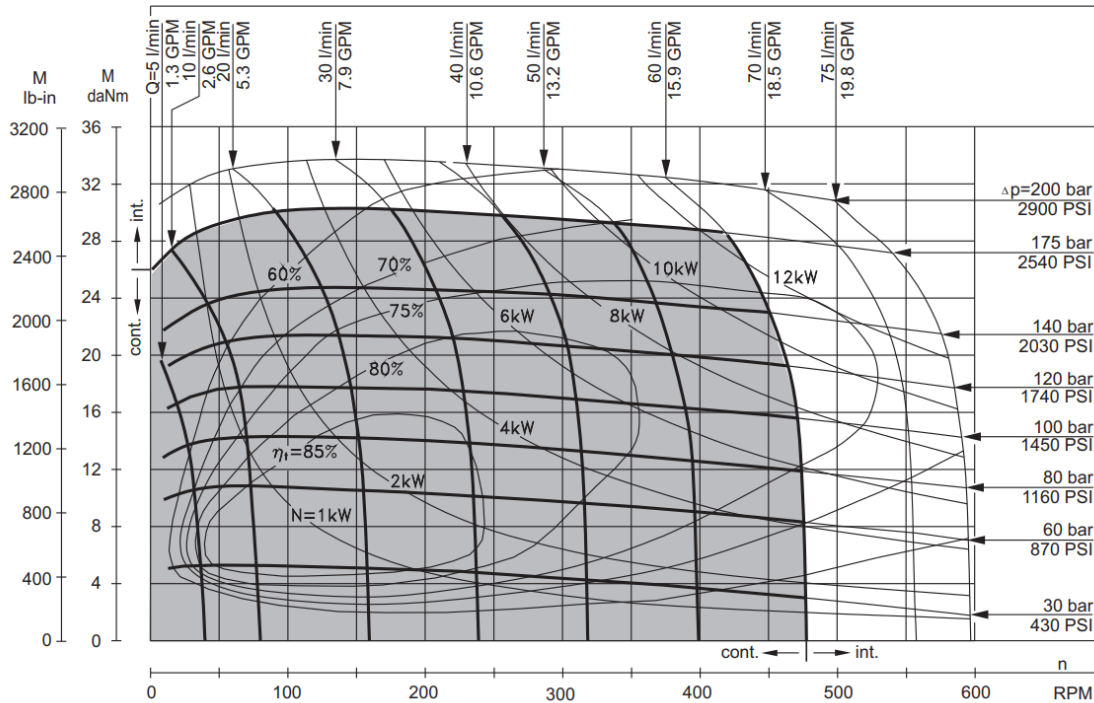

MR 160

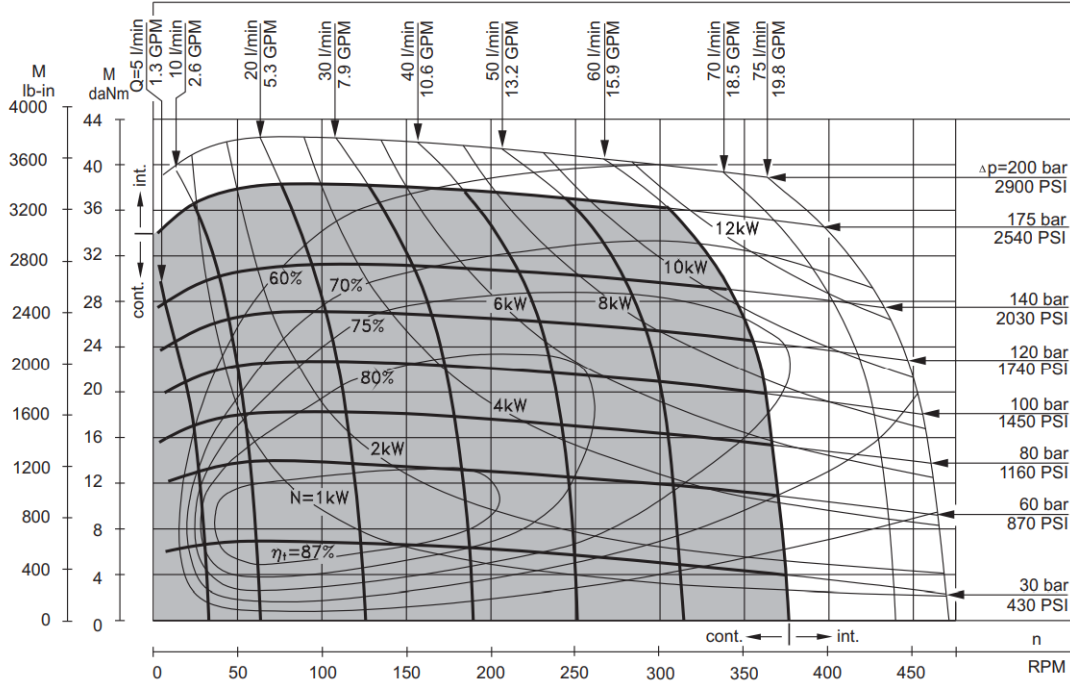

MR 200

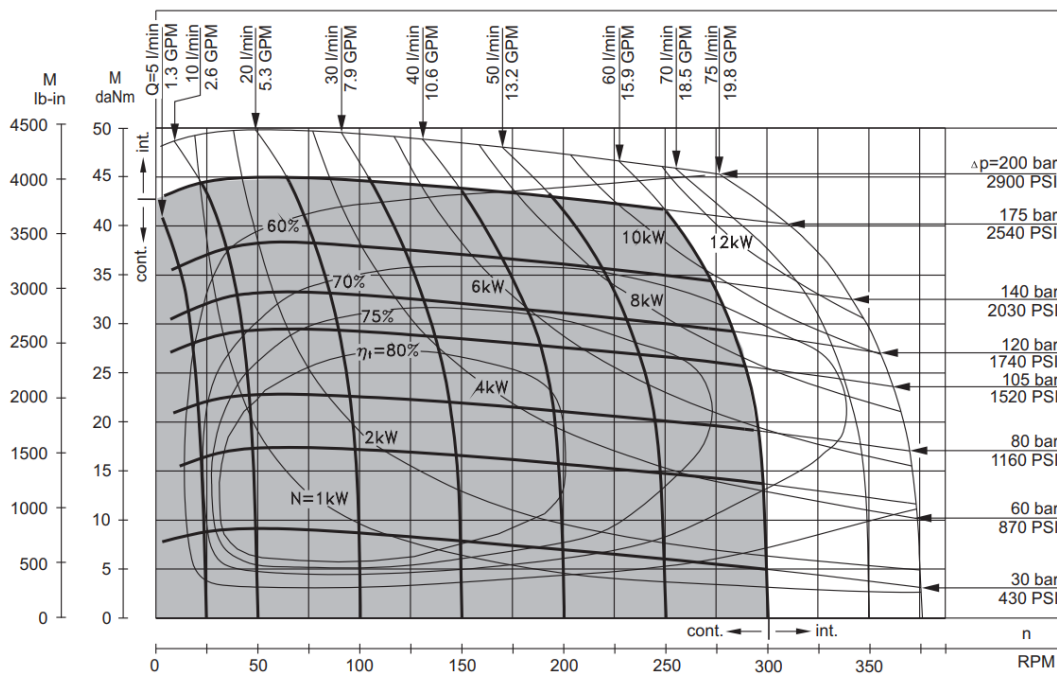

MR 250

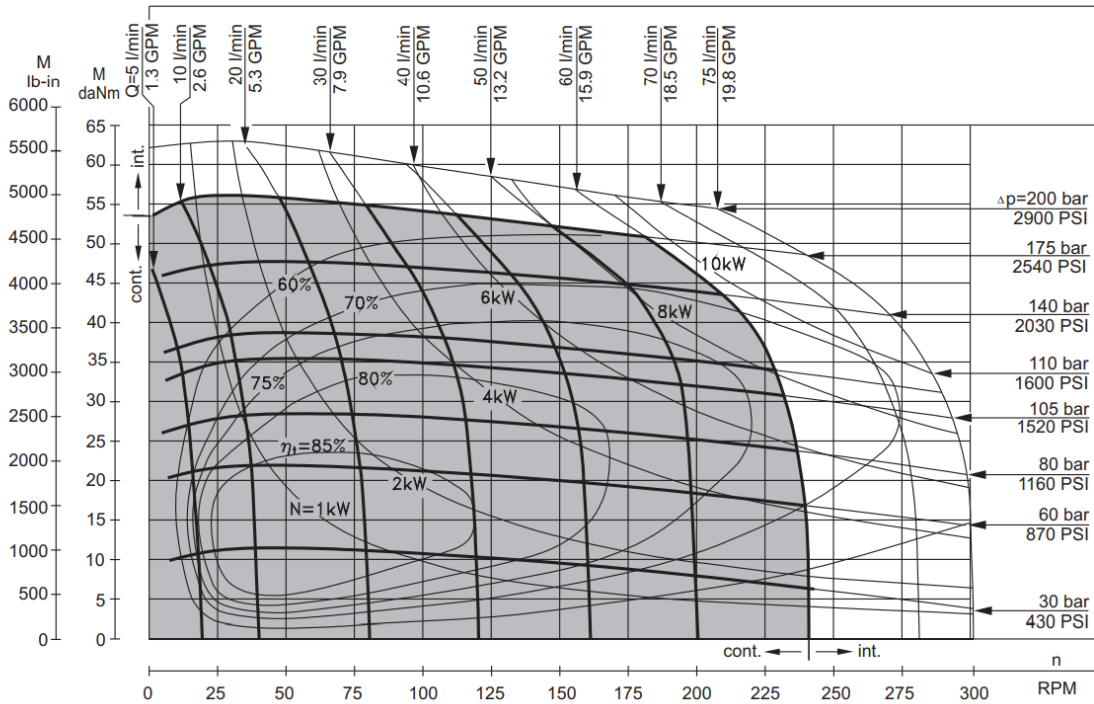

MR 315

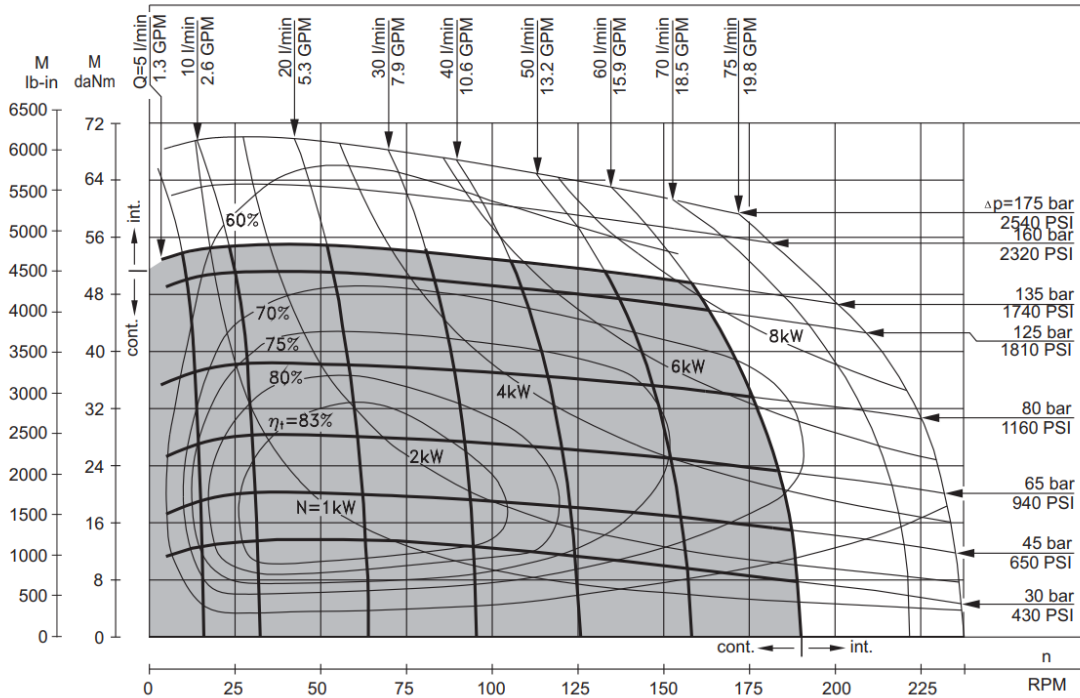

MR 400

